

CUSTOMISED CLINICAL IMAGE IES - MULTILEVEL



CASTELLINI IES FILTERS (IMAGE ENHANCEMENT SYSTEM)

Latest-generation X-VS image processing software aims to improve diagnostics. With excellent image resolution and a user-friendly software interface, X-VS makes reading intraoral images simpler and easier. The new CASTELLINI iES (Image Enhancement System) filters are the result of research that focuses on dentists' real needs. By using proprietary algorithms optimised for the X-VS sensor, dentists can simultaneously capture, display and share a set of Multi Level images (up to 5). Each image is the result of a different improvement designed to highlight various anatomical details with different levels of sharpness. Dentists can customise image contrast to suit their diagnostic or visual preferences, allowing improved diagnosis. Afterwards, favourite settings can be rendered automatic.

RXDC X-VS IMAGING

Equipped with advanced iRYS software, the X-VS now offers the versatile MultiLEVEL function, which lets users pre-set the image processing filters displayed in Multi Level. Users can select which filters to use from among the pre-set families and define any further customisations, all from the iRYS image display window. This provides individual dentists with a customised comfort zone for every appointment.

THE PERFECT DIMENSION OF IMAGING



Making Your Life Smarter

06/2021 CIMA08201510

Due to our policy of constant technological upgrading the technical specifications may be subject to change without prior notice. According to the standards in force, in extra-EU areas the availability and specifications of some products and/or characteristics may vary. Please contact your local distributor for further information.



RXDC X-VS IMAGING THE PERFECT DIMENSION OF IMAGING

SENSOR: X-VS	Size 1 - Regular	Size 2 - Large
External dimensions (mm)	38.9 x 24.9	41.9 x 30.4
Thickness (mm)	5.3	5.7
Pixel matrix	1500 x 1000	1700 x 1300
Pixel size (µm)	20	20
Maximum resolution (lp/mm)	25	25
Grey levels depth	14-bit acquisition - 16384 maximum grey levels	
Scintillator technology	CsI (Cesium Iodide) with micro-columnar structure	
Direct exposure protection	FOP (Fibre Optics Plate)	
Protection rating	IP 67 (Guaranteed against liquid or dust infiltration)	
Compatibility with X-ray generators	Any AC or DC technology X-ray generator with kV values in the 60 – 70 kV range and precision control of exposure times	
Connectivity	Direct USB to PC	
Image capture software (for PC)	iCapture with dedicated filters for third party software	
Image management software (for PC)	iRYS (as per ISDP®10003:2018 in compliance with EN ISO/IEC17065:2012 - certificate number 2019003109-1) and iPad iRYS viewer app (free)	
Supported protocols	DICOM 3.0, TWAIN, VDDIS	
DICOM nodes	IHE compliant (Print, Storage Commitment, SR document; WorkList; MPPS; Query/Retrieve)	
Minimum system requisites		
Supported operating systems	Microsoft® Windows® 10 Professional 64 bit	
Display settings	1280x1024; 1344 x768 or greater, 16 million colours	
Port	USB 2.0 or subsequent	
Power supply	5 V DC, 500 mA (via USB)	

RXDC X-RAY UNIT	
Generator	Constant potential, microprocessor-controlled
Working frequency	145 - 230 KHz with self-adjustment (typically 175 KHz)
Focal spot	0.4 mm (IEC 336)
Total filtration	2.0 mm Al @ 70kV
Anode current	4 / 8 mA
Voltage at X-ray tube	60 / 65 / 70 kV (*)
Exposure times	0.020 – 1.000 seconds, R'10 and R'20 scale
Source-skin distance	20 and 30 cm
Irradiated field	Ø 60 mm and Ø 55 mm [with round cone]
Additional collimators	35 x 45 mm [with rectangular cone for size 2 sensors], 31 x 41 mm and 22 x 35 mm, for size 1 and size 0 sensors
Power supply	50/60 Hz, 115-120 V AC ±10% or 230-240 V AC ±10%
Duty Cycle	Continuous operation with self-adjustment up to 1s/90s total
Arms (for Standard version only)	Available in 3 lengths: 40 cm – 60 cm – 90 cm
Max. arm extension	230 cm, from wall
Versions	Standard (wall mounted) or Mobile (on portable cart)

(*) values depend on the country where the product is marketed.

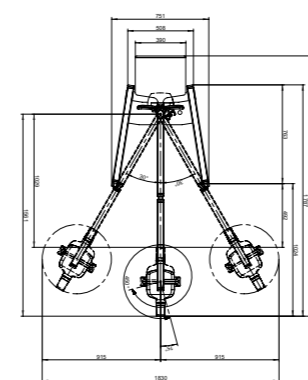
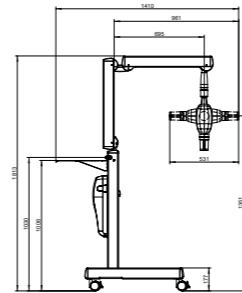
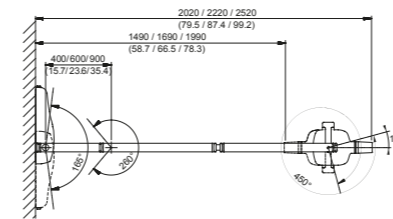
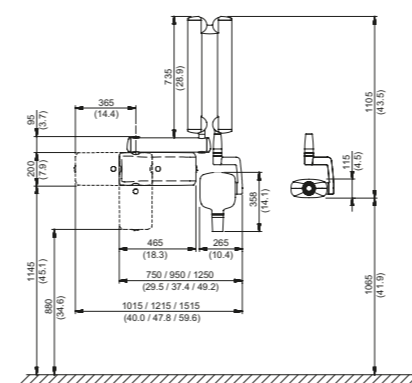
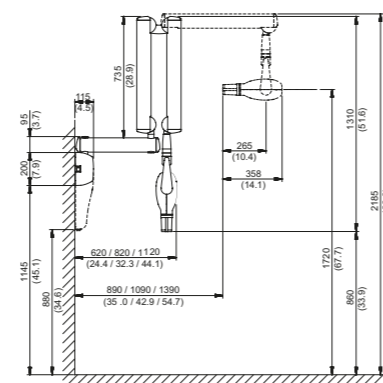

RXDC X-VS IMAGING THE PERFECT DIMENSION OF IMAGING

CASTELLINI.COM



CASTELLINI
PASSION FOR DENTISTRY SINCE 1935

IMMEDIATE DIAGNOSIS, EXCELLENT RESULTS



The RXDC is a versatile, user-friendly X-ray unit, capable of producing high quality imaging thanks to cutting-edge technology. It also maximises working comfort while ensuring low X-ray doses for the patient and maintaining ultra-high performance. The RXDC, in fact, uses a constant potential high frequency (DC) generator and a very small focal spot (0.4 mm) that provides sharp, detailed images. Automatic exposure parameter modulation and accurate power selection make the RXDC the perfect X-ray unit whatever the situation, personalised according to the patient's build and the specific region of investigation. The RXDC is the perfect X-ray unit, capable of combining high quality imaging and a versatile, ergonomic design with low patient doses.

Innovative ergonomics, direct USB plug-and-play connection, high definition and immediate results make the X-VS with X-VISUS HD technology the most advanced and suitable sensor for your surgery. Simplicity of use and image acquisition - combined with advanced real-time digital technology - improve quality of work. Impact-resistant, dust-resistant and certified IP67 (water-resistant), the X-VS - X-VISUS HD technology can be used with all X-ray systems. The X-VS - X-VISUS HD technology uses iRYS, the all-in-one software for diagnostics, communication and management of intraoral imaging which allows flawless storage, processing and printing of images in perfect synergy with any other devices already in the surgery.

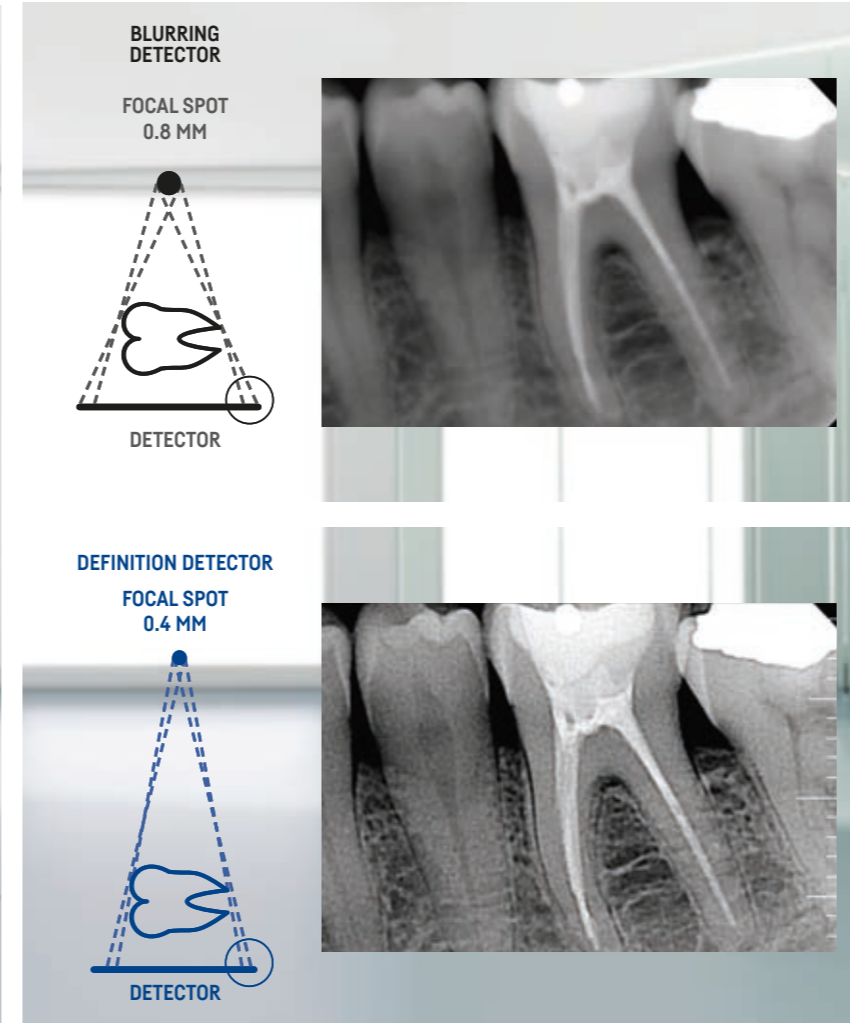

MINIMUM DOSE, HIGH DEFINITION, HIGH FREQUENCY RXDC X-RAY UNIT

The RXDC increases X-ray parallelism: thanks to the incorporated collimator the RXDC can achieve a source-to-skin gap of 30 cm. Sharp edges, clear images and precise detail, all while keeping patient doses low. Ergonomic design, offers simplicity and reliability thanks to solid extruded aluminium arms with an integrated self-balancing system. Arm and tube head positioning is comfortable and stable. The protractor with graduated scale allows easy positioning.



MAXIMUM VERSATILITY AND MOBILITY

The RXDC is now even more practical and versatile, wall-mounted with 6 variable positions - 3 extensions available in the following lengths: 40, 60 and 90 cm - or, thanks to the cart, it can easily be moved around for use in different areas of the surgery. One X-ray unit for all your needs.



COLLIMATOR CONES

With the built-in collimator cone, a focus-skin distance of 30 cm can be reached. The optional rectangular cone further reduces the body area exposed to X-rays.



USER-FRIENDLY CONTROL

Simple, user-friendly handheld unit, can be used to select the most suitable programme and ensure perfect X-ray acquisition. Moreover, thanks to the fast Dynamic Duty-Cycle, it is possible to keep tube temperature under control and check - in real time - the exact administered dose.

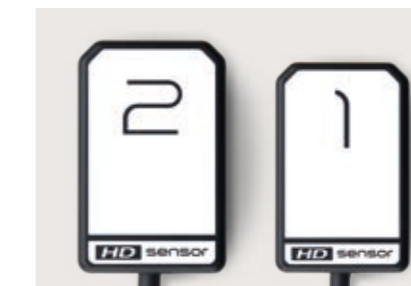

MADE-TO-MEASURE SENSOR

X-VS - X-VISUS HD technology allows users to choose between two sensor sizes; these make it more adaptable to the dimensions of the patient's oral cavity. Outstanding positioning comfort thanks to rounded corners; high performance, compact design and a maximised active area.

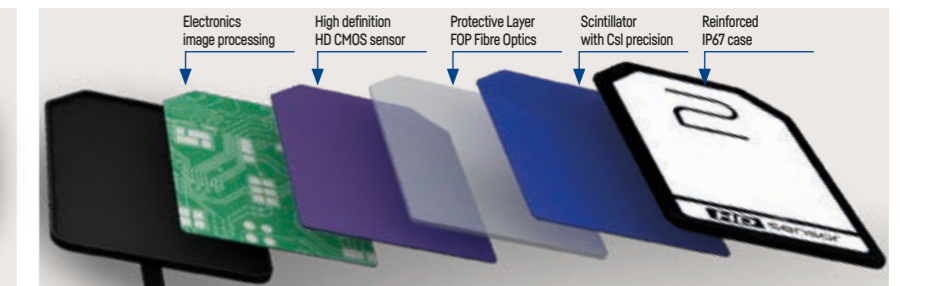

LATEST-GENERATION HD SENSOR

4-layer sensor with an additional protective layer to provide sharp, high-contrast images. Caesium Iodide [CsI] scintillator made up of column-like micro-structures that preserve image quality; it first intercepts the X-ray beam and converts it into visible light. The Fibre Optics Plate (a layer of fibre optics) collimates the radiation onto the sensor and protects it against direct X-ray penetration. The high definition [CMOS HD] acquisition device and on-board electronics convert the light into a digital image with 16,384 grey levels.